

## 3 METROS - RETO COM BASE E CHUMBADORES

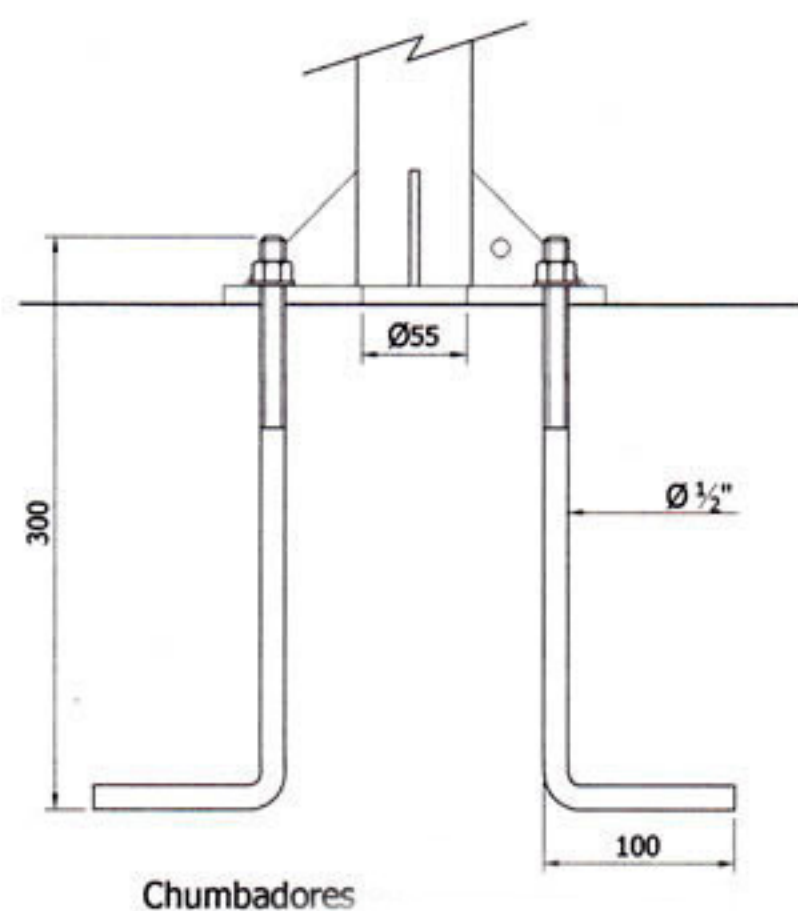
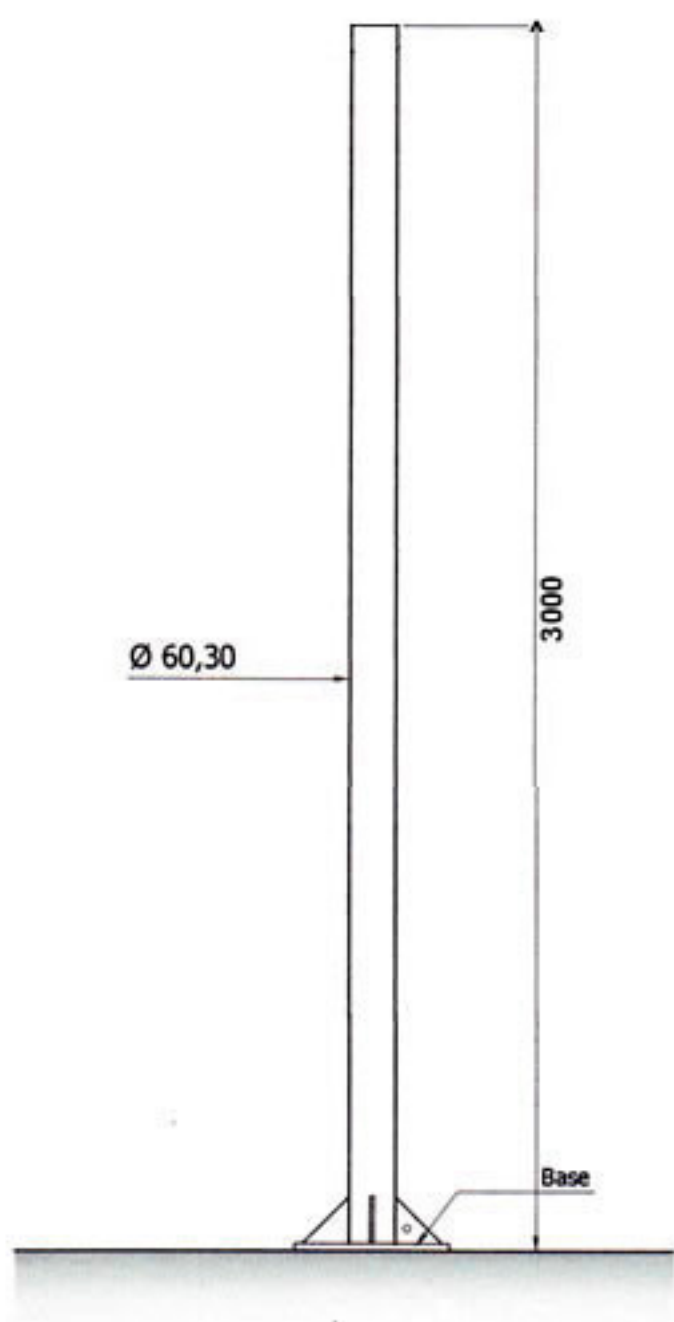
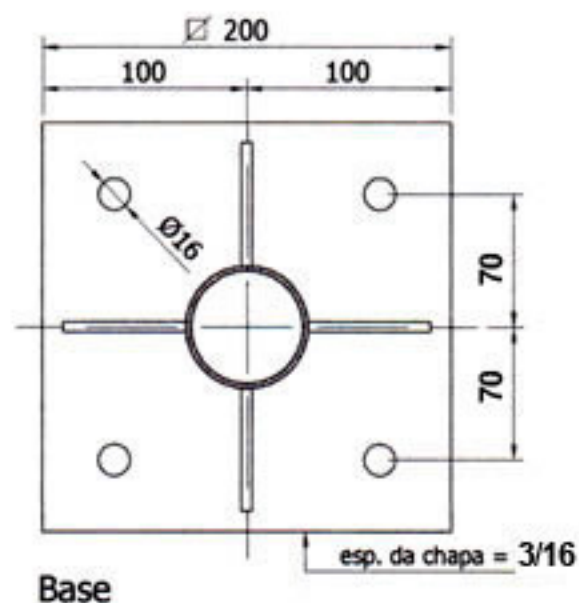

### Notas:

- Dimensões em milímetros;
- Galvanizado a fogo;
- Tolerância geral de 2%
- Conformidade Norma ABNT 14.744
- Ruptura Vertical/Horizontal 100DAN sem ruptural.

### Descrição:

Poste Reto com Base e Chumbadores 3000 mm