

9 METROS - CURVO SIMPLES - BASE E CHUMBADORES

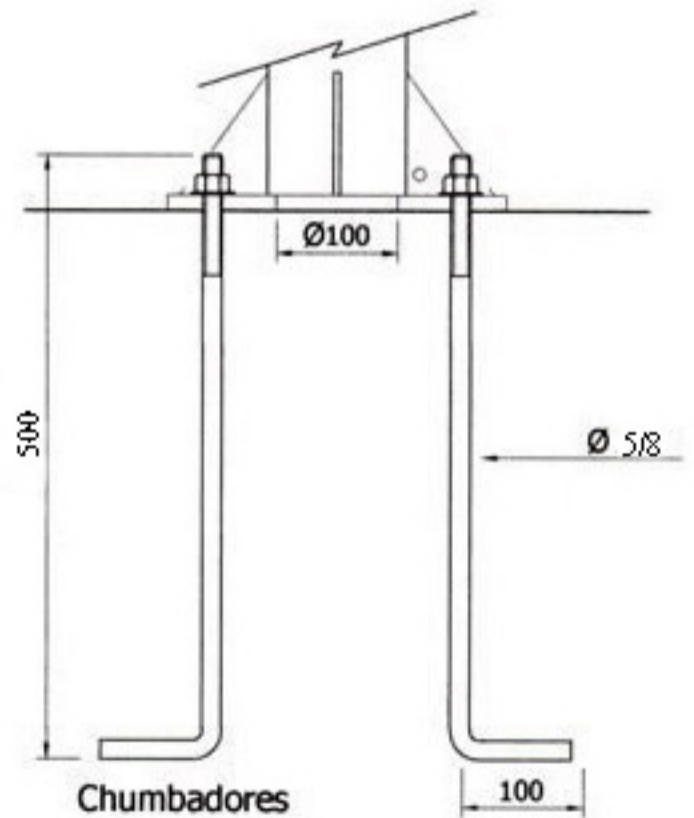
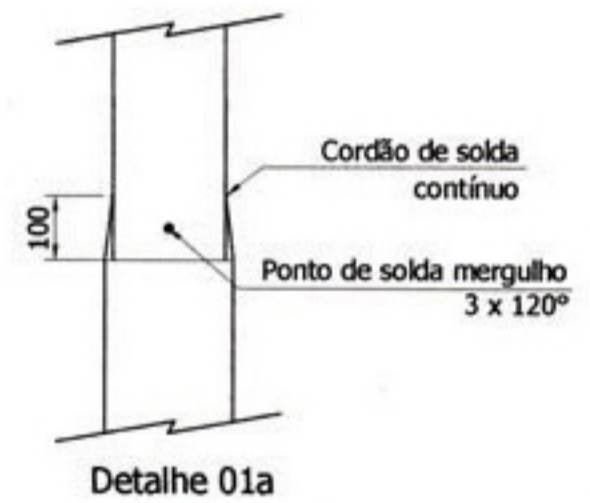
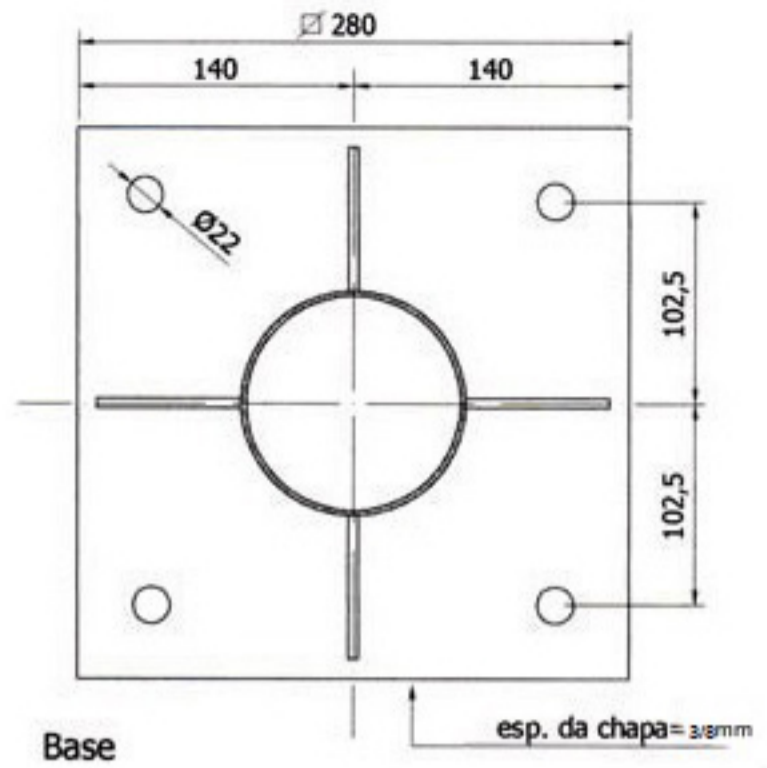
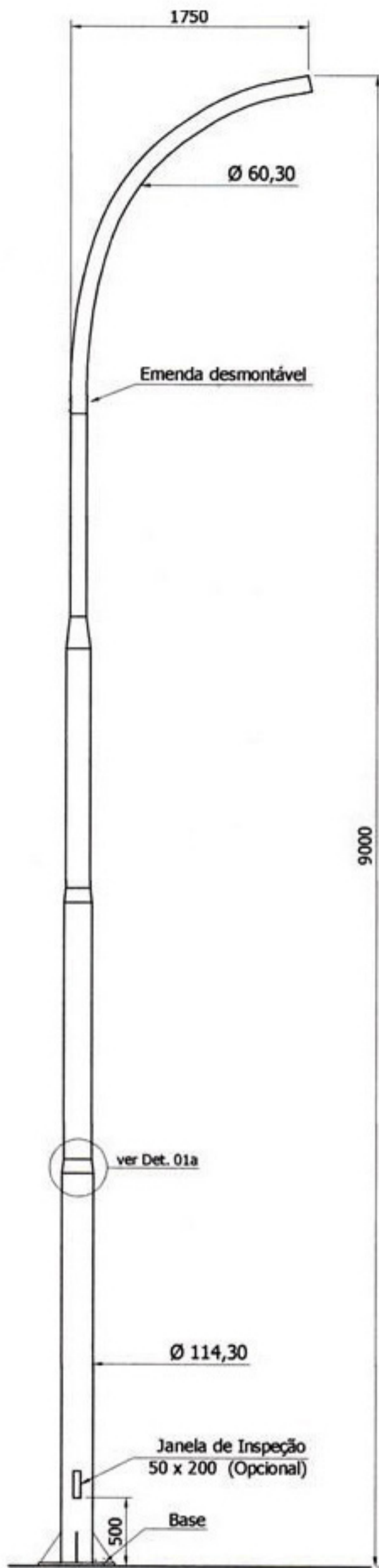

Notas:

- Dimensões em milímetros;
- Galvanizado a fogo;
- Tolerância geral de 2%
- Conformidade Norma ABNT 14.744
- Ruptura Vertical/Horizontal 100DAN sem ruptural.