

# 3 METROS - CURVO DUPLO - BASE E CHUMBADORES

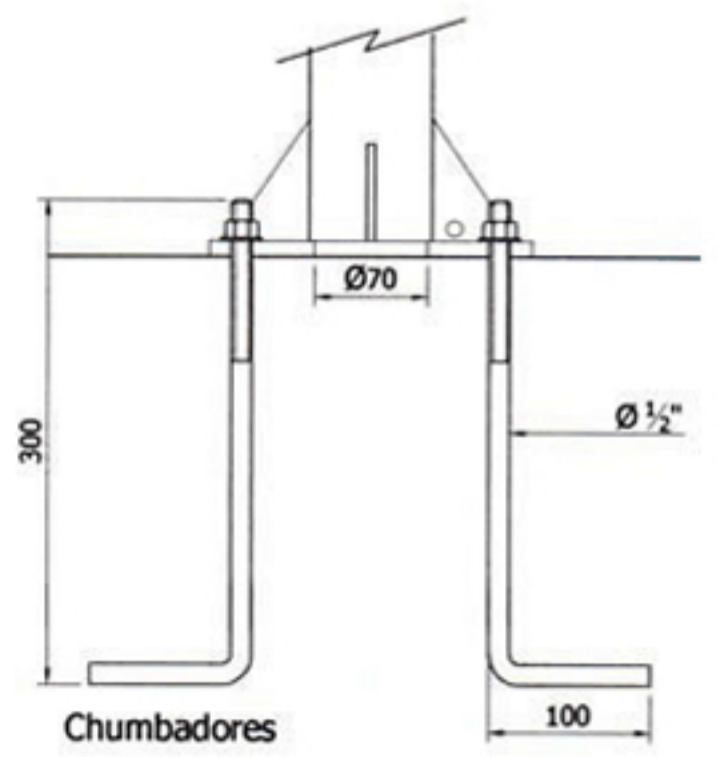

- Notas:**
- Dimensões em milímetros;
  - Galvanizado a fogo;
  - Tolerância geral de 2%
  - Conformidade Norma ABNT 14.744
  - Ruptura Vertical/Horizontal 100DAN sem ruptural.

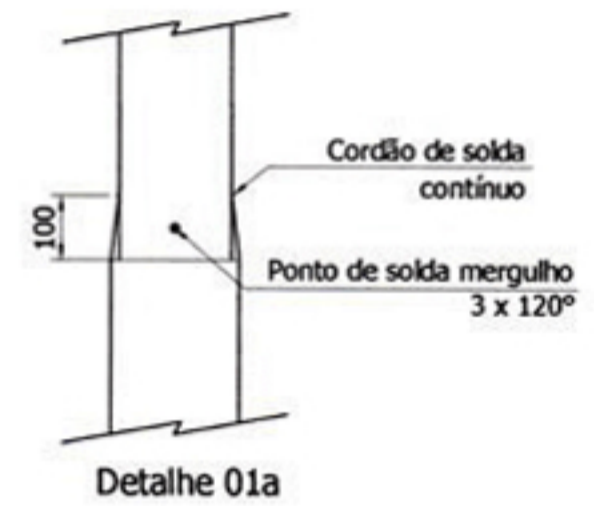
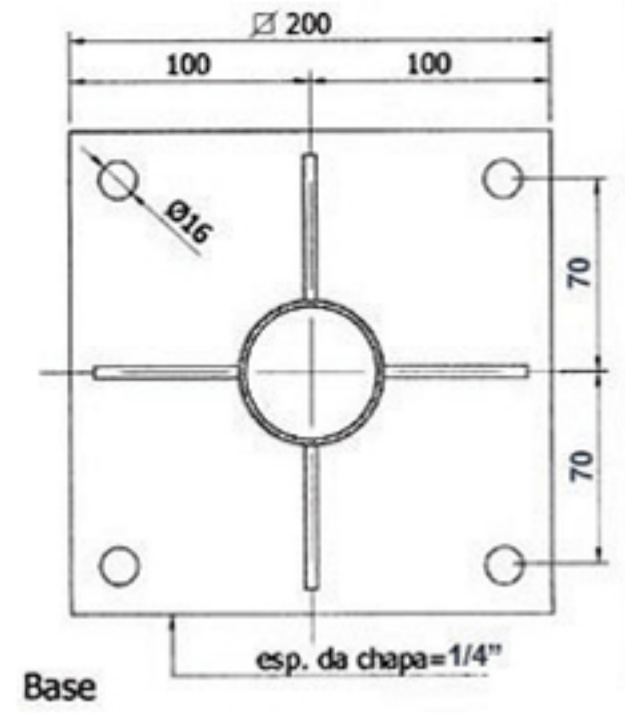
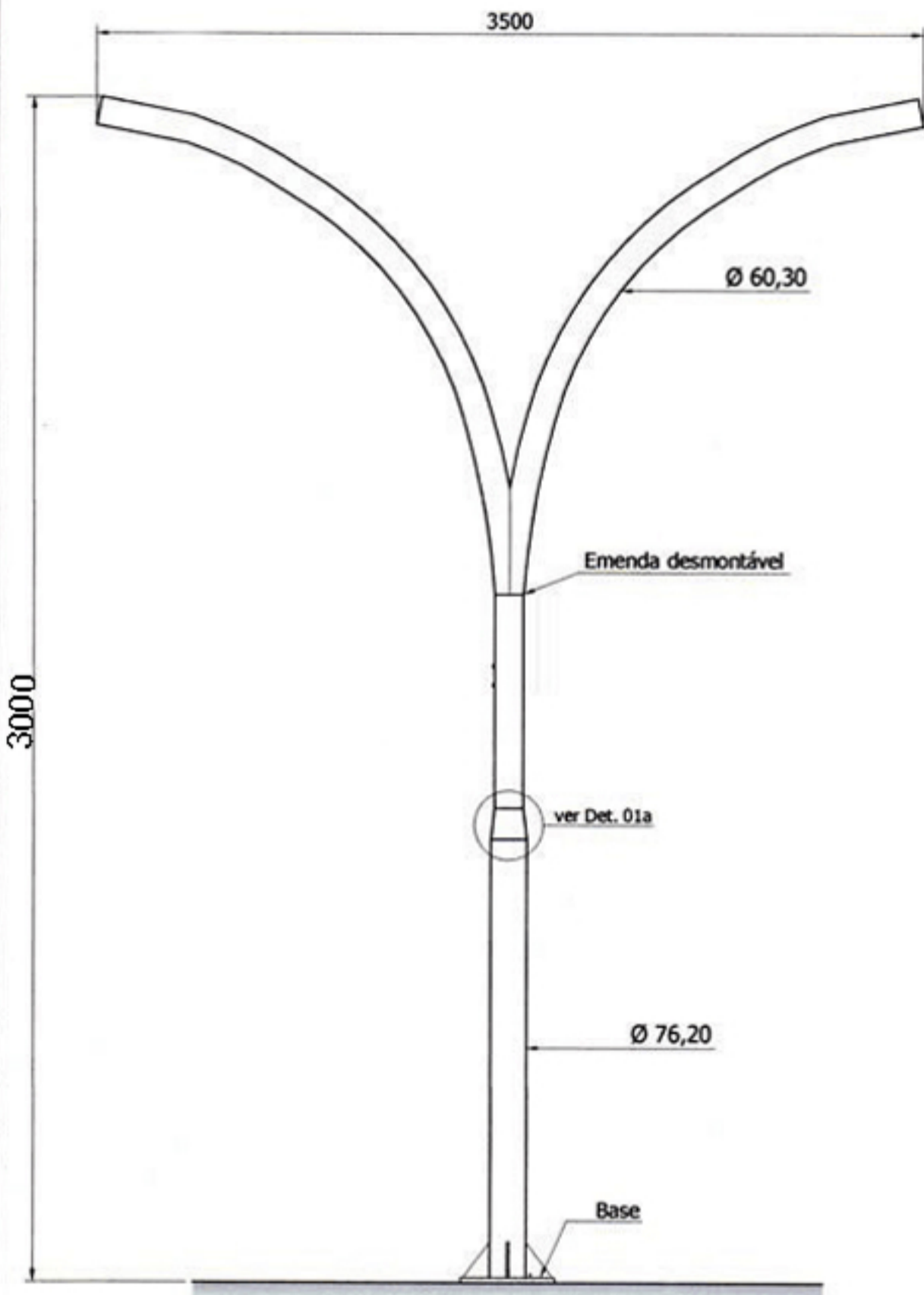

DISTRIBUIDO POR: LUZ LED ILUMINAÇÃO

**Descrição:**  
Poste Curvo Duplo com Base e Chumbadores 3000 mm